

평 면 도  
scale : None

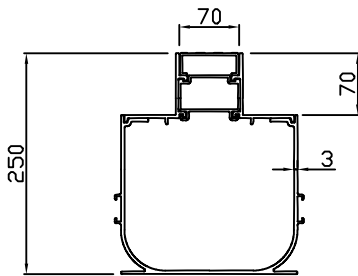

정 면 도  
scale : None

타공커버

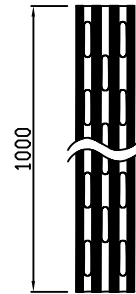

평 면 도  
scale : None

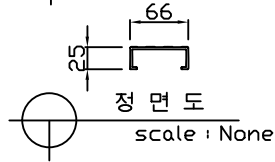

정 면 도  
scale : None

연결소켓

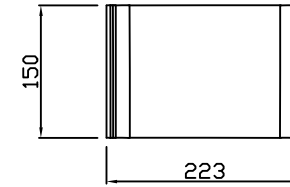

평 면 도  
scale : None

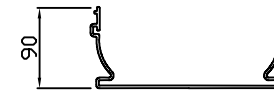

정 면 도  
scale : None

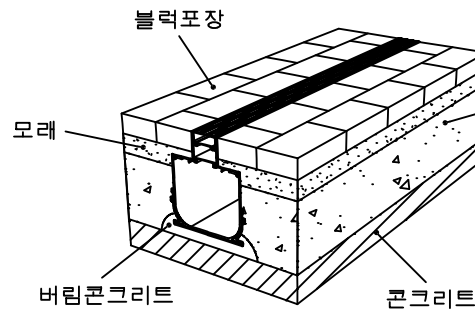

설치예시도 1  
scale : None

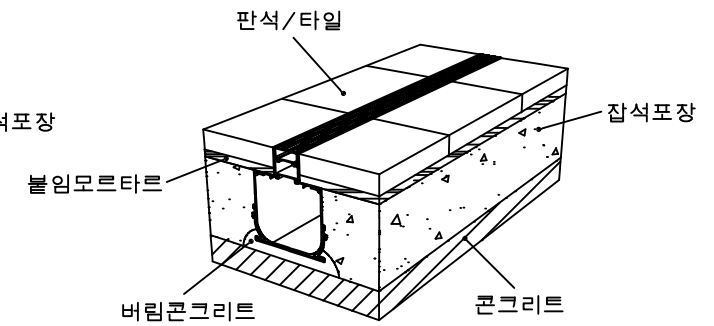

설치예시도 2  
scale : None

|               |        |               |              |
|---------------|--------|---------------|--------------|
| PROJECT TITLE | AL수로관  | SUBJECT TITLE | DATE         |
| MATERIAL      | WEIGHT | SIZE          | 214*250*3000 |
|               | Kg     |               |              |

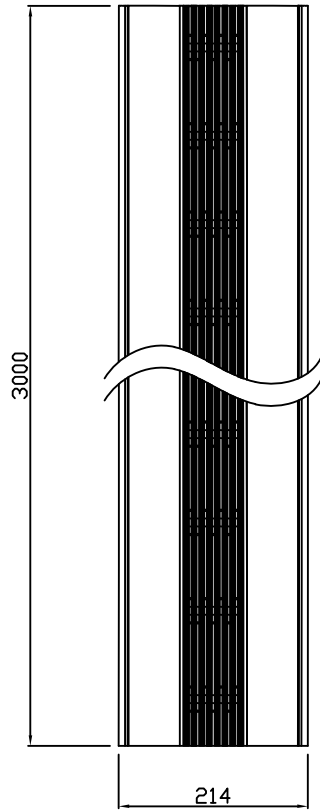

평면도  
scale : None

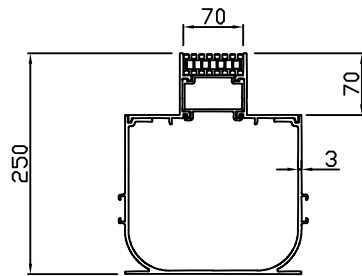

정면도  
scale : None

데크그레이팅

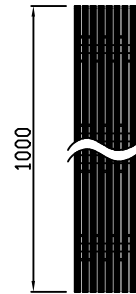

평면도  
scale : None

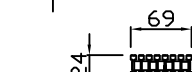

정면도  
scale : None

연결소켓

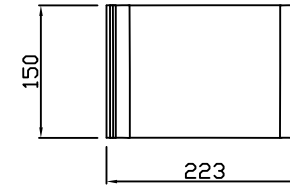

평면도  
scale : None

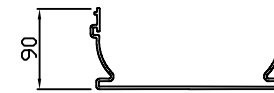

정면도  
scale : None

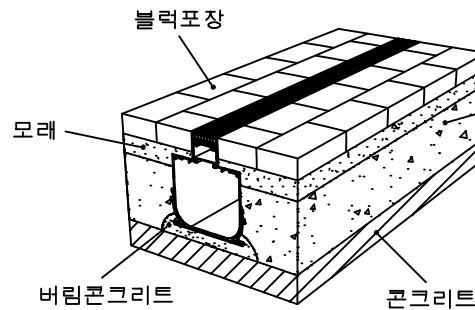

설치예시도 1  
scale : None

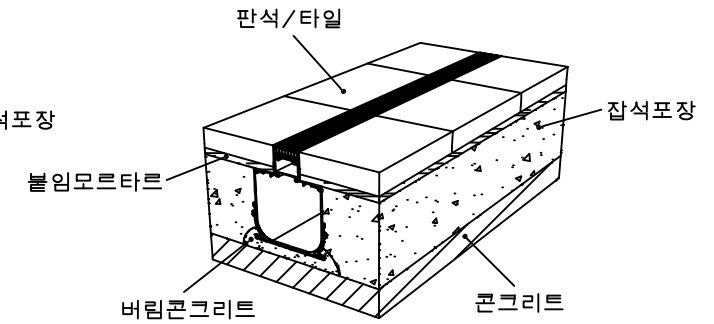

설치예시도 2  
scale : None

|               |        |               |              |
|---------------|--------|---------------|--------------|
| PROJECT TITLE | AL수로관  | SUBJECT TITLE | DATE         |
| MATERIAL      | WEIGHT | SIZE          | 214*250*3000 |
|               | Kg     |               |              |

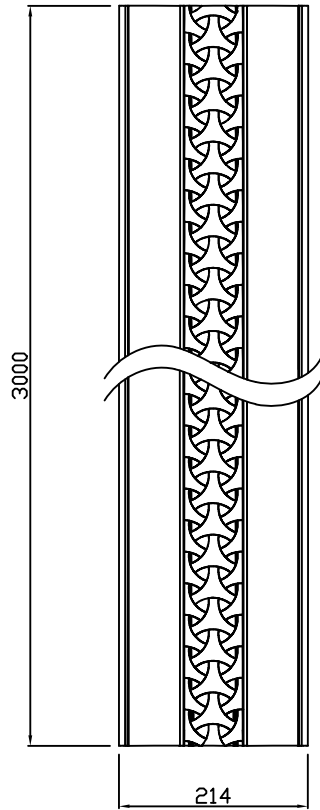

평 면 도  
scale : None

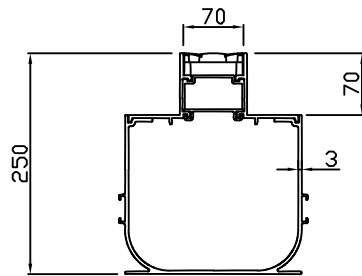

정 면 도  
scale : None

주철디자인커버

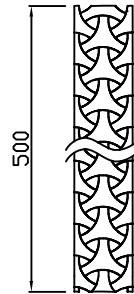

평 면 도  
scale : None

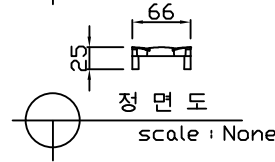

정 면 도  
scale : None

연결소켓

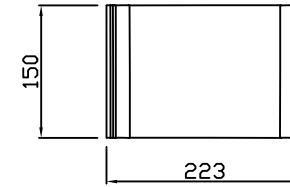

평 면 도  
scale : None

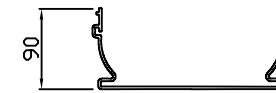

정 면 도  
scale : None

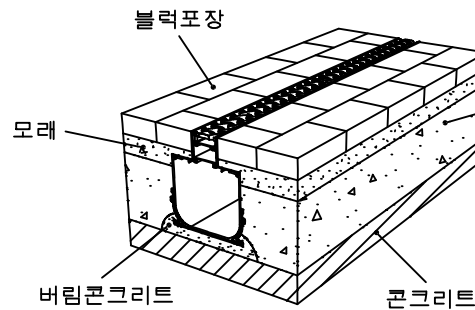

설치예시도 1  
scale : None

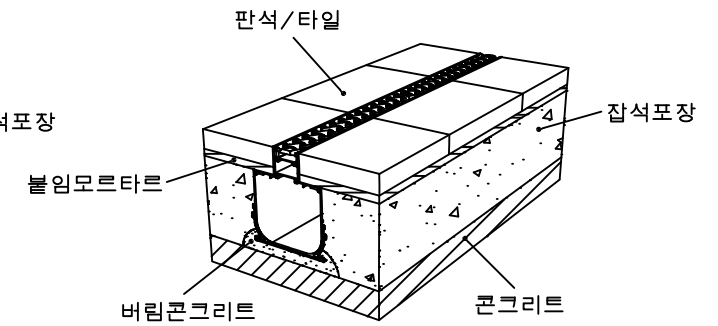

설치예시도 2  
scale : None

|               |       |               |    |      |              |
|---------------|-------|---------------|----|------|--------------|
| PROJECT TITLE | AL수로관 | SUBJECT TITLE |    | DATE |              |
| MATERIAL      |       | WEIGHT        | Kg | SIZE | 214*250*3000 |